

PowerAmp Design

HIGH VOLTAGE OPERATIONAL AMPLIFIER

PAD112

Rev D

KEY FEATURES

- LOW COST
- HIGH VOLTAGE – 150 VOLTS
- HIGH OUTPUT CURRENT – 5 AMPS
- 50 WATT DISSIPATION CAPABILITY
- 100 WATT OUTPUT CAPABILITY
- INTEGRATED HEAT SINK AND FAN
- COMPATIBLE WITH PAD125 MODULE
-  RoHS COMPLIANT (JAN 2014)

APPLICATIONS

- LINEAR MOTOR DRIVE
- HIGH VOLTAGE INSTRUMENTATION
- SEMICONDUCTOR TESTING

DESCRIPTION

The PAD112 high voltage operational amplifier is constructed with surface mount components to provide a cost effective solution for many industrial applications. With a footprint only 3.8 in² the PAD112 offers outstanding performance that rivals more expensive hybrid component amplifiers or rack-mount amplifiers. User selectable external compensation tailors the amplifier's response to the application requirements. Four-wire programmable current limit is built-in but the PAD112 is also compatible with the precision PAD125 Current Limit Accessory Module. The PAD112 also features a substrate temperature reporting output and over-temp shutdown. The amplifier circuitry is built on a thermally conductive but electrically insulating substrate mounted to an integral heat sink and fan assembly. No BeO is used in the PAD112. The resulting module is a small, high performance turn-key solution for many industrial applications.

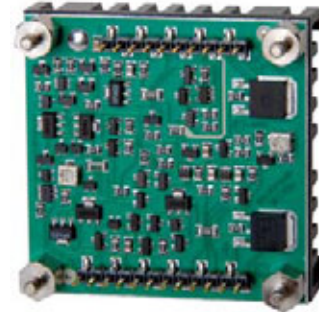

PAD112

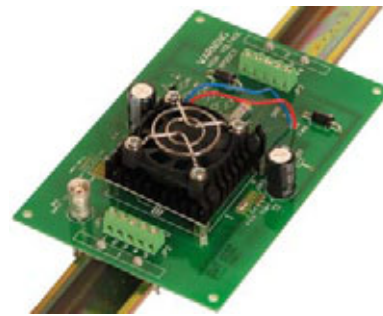

PAD112 INSTALLED IN EVALUATION KIT

A NEW CONCEPT

A critical task in any power amplifier application is cooling the amplifier. Until now component amplifier manufacturers often treated this task as an after-thought, left for the user to figure out. At **Power Amp Design** the best heat sink and fan is chosen at the start and becomes an integral part of the overall amplifier design. The result is the most compact and volumetric efficient design combination at the lowest cost. In addition, this integrated solution concept offers an achievable real-world power dissipation rating, not the ideal rating usually cited when the amplifier case is somehow kept at 25°C. The user no longer needs to specify, procure or assemble separate components.

PowerAmp Design ♦ PAD112 ♦ HIGH VOLTAGE OPERATIONAL AMPLIFIER

EQUIVALENT CIRCUIT

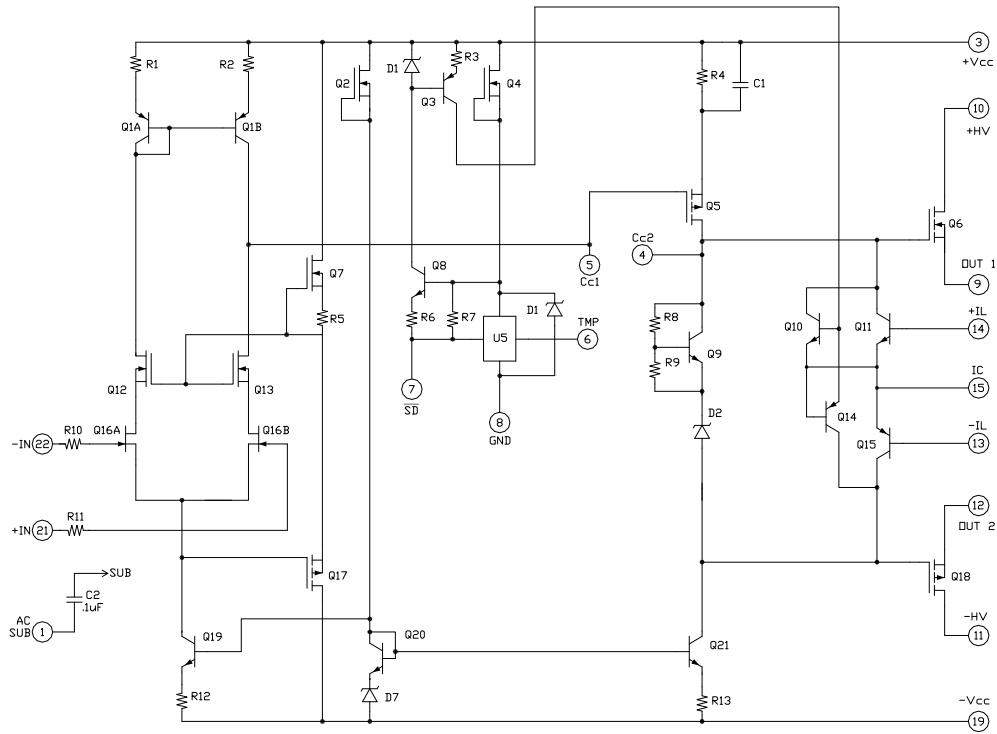

PINOUT & CONNECTIONS

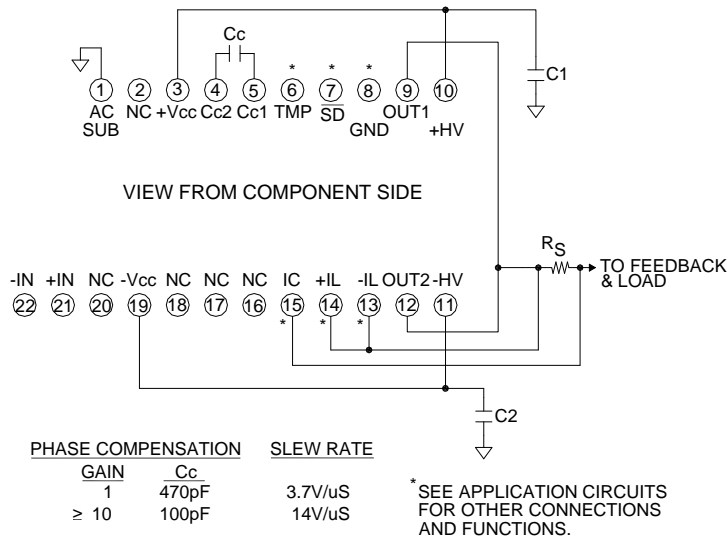

ABSOLUTE MAXIMUM RATINGS			
SUPPLY VOLTAGE, +HV to -HV	150V	INPUT VOLTAGE	+Vcc to -Vcc
SUPPLY VOLTAGE, +Vcc to -Vcc	150V	DIFFERENTIAL INPUT VOLTAGE	± 20V
SUPPLY VOLTAGE, +Vcc	+HV+15V ⁷	TEMPERATURE, pin solder, 10s	300°C
SUPPLY VOLTAGE, -Vcc	-HV-15V ⁷	TEMPERATURE, junction ²	175°C
OUTPUT CURRENT, peak	10A, within SOA	TEMPERATURE RANGE, storage	-40 to 70°C ⁵
POWER DISSIPATION, internal, DC	50W	OPERATING TEMPERATURE, heat sink	-40 to 105°C

PARAMETER	TEST CONDITIONS ¹	MIN	TYP	MAX	UNITS
INPUT					
OFFSET VOLTAGE			1	3	mV
OFFSET VOLTAGE vs. temperature	Full temperature range		20	50	μV/°C
OFFSET VOLTAGE vs. supply				20	μV/V
BIAS CURRENT, initial ³				100	pA
BIAS CURRENT vs. supply				0.1	pA/V
OFFSET CURRENT, initial				50	pA
INPUT RESISTANCE, DC			100		G Ω
INPUT CAPACITANCE			4		pF
COMMON MODE VOLTAGE RANGE				+Vcc-15	V
COMMON MODE VOLTAGE RANGE				-Vcc+7	V
COMMON MODE REJECTION, DC		110	128		dB
NOISE	100kHz bandwidth, 1kΩ R _s		10		μV RMS
SHUTDOWN (SD)	Grounded			1	mA
GAIN					
OPEN LOOP	R _L = 10kΩ, C _C =100pF	108			dB
GAIN BANDWIDTH PRODUCT @ 1MHz	C _C =100pF		2		MHz
PHASE MARGIN	Full temperature range	45			degree
OUTPUT					
VOLTAGE SWING	I _O = 5A	+HV-7	+HV-6		V
VOLTAGE SWING	I _O = -5A	-HV+7	-HV+6		V
CURRENT, continuous, DC				5	A
SLEW RATE, A _v = -10	C _C = 100pF	11	14		V/μS
SETTLING TIME, to 0.1%	2V Step, C _C = 100pF		6		μS
RESISTANCE	No load, DC		8		Ω
POWER SUPPLY					
VOLTAGE		± 15	± 50	± 75	V
CURRENT, quiescent			18	22	mA
CURRENT, shutdown, pin 7 low			1.2	1.7	mA
THERMAL					
RESISTANCE, AC, junction to air ⁶	Full temperature range, f ≥ 60Hz			2	°C/W
RESISTANCE, DC junction to air, outputs	Full temperature range			2.7	°C/W
TEMPERATURE RANGE, heat sink		-40		105	°C
FAN, 40mm dc brushless, ball bearing					
OPERATING VOLTAGE			12		V
OPERATING CURRENT			50		mA
AIR FLOW			7.5		CFM
RPM			7000		RPM
NOISE			30		dB
L10, life expectancy, 50°C ⁸			45		kHrs
L10, life expectancy, 25°C ⁸			60		kHrs

NOTES:

1. Unless otherwise noted: T_c = 25°C, compensation C_c = 470pF, DC input specifications are ± value given, power supply voltage is typical rating.
2. Derate internal power dissipation to achieve high MTBF.
3. Doubles for every 10°C of case temperature increase.
4. +HV and -HV denote the positive and negative supply voltages to the output stage. +Vcc and -Vcc denote the positive and negative supply voltages to the input stages.
5. Limited by fan characteristics. During operation, even though the heat sink may be at 85°C or more the fan will be at a lower temperature.
6. Rating applies if the output current alternates between both output transistors at a rate faster than 60Hz.
7. Power supply voltages +Vcc and -Vcc must not be less than +HV and -HV respectively. Total voltage +Vcc to -Vcc 150V maximum.
8. L10 refers to the time it takes for 10% of a population of fans to fail. Lower ambient temperature increases fan life.

SAFETY FIRST

The operating voltages of the PAD112 are potentially deadly. When developing an application circuit it is wise to begin with power supply voltages as low as possible while checking for circuit functionality. Increase supply voltages slowly as confidence in the application circuit increases. Always use a “hands off” method whereby test equipment probes are attached only when power is off.

COOLING FAN

The PAD112 relies on its fan for proper cooling of the amplifier. Make sure that air flow to the fan and away from the heat sink remains unobstructed. To eliminate electrical noise created by the cooling fan we recommend a 47 μ F capacitor placed directly at the point where the fan wires connect to the PCB. See application note AN-24 for further details.

CURRENT LIMIT

The current limiting function of the PAD112 is a versatile circuit that can be used to implement a four-wire current limit configuration or, in combination with some external components can be configured to implement a fold-over current limit circuit. The four-wire current limit configuration insures that parasitic resistance in the output line, R_p , does not affect the programmed current limit setting. See Figure 1. The sense voltage for current limit is 0.65V. Thus:

$$I_L = \frac{0.65V}{R_s}$$

Where I_L is the value of the limited current and R_s is the value of the current limit sense resistor.

In addition, the sense voltage has a temperature coefficient approximately equal to $-2.2\text{mV}/^\circ\text{C}$. The fold-over function reduces the available current as the voltage across the output transistors increases to help insure that the SOA of the output transistors is not exceeded. Refer to **Application Circuits** for details on how to connect the current limit circuitry to implement either a four-wire current limit or current limit with a fold-over function. The PAD112 is also compatible with the precision PAD125 Current Limit Accessory Module. See Figure 4 and the datasheet for the PAD125 for further details.

MOUNTING THE AMPLIFIER

The amplifier is supplied with four 4-40 M/F hex spacers at the four corners of the amplifier. Once the amplifier is seated, secure the module with the provided 4-40 nuts and torque to 4.7 in lb [53 N cm] max. See “**Dimensional Information**” for a detailed drawing. It is recommended that the heat sink be grounded to the system ground. This can easily be done by providing a grounded circuit board pad around any of the holes for the mounting studs.

TEMPERATURE REPORTING

An analog output voltage is provided (pin 6, TMP) relative to ground and proportional to the temperature in degrees C. The slope is approximately $-10.82\text{mV}/^\circ\text{C}$. The output voltage follows the equation:

$$T = (2.127 - V) (92.42)$$

Where V is the TMP output voltage and T is the substrate temperature in degrees C.

THERMAL SHUTDOWN

The temperature monitoring circuit automatically turns off the amplifier when the substrate temperature reaches 110°C . When the substrate cools down 10°C the amplifier is enabled once again. The thermal shutdown feature is activated either by amplifier overloads or a failure of the fan circuit.

EXTERNAL SHUTDOWN

When pin 7 (\overline{SD}) is taken low (ground) the amplifier is turned “off” and remains “off” as long as pin 7 is low. When pin 7 is monitored with a high impedance circuit it also functions as a flag, reporting when the amplifier is shut down. A “high” (+5V) on pin 7 indicates the temperature is in the normal range. A “low” (ground) indicates a shutdown condition. See **Application Circuits** for details on how to implement an external shutdown circuit and how to monitor the shutdown status when temperature is in the normal range. A “low” (ground) indicates a shutdown condition. See **Application Circuits** for details on how to implement an external shutdown circuit and how to monitor the shutdown status.

PHASE COMPENSATION

The PAD112 **must** be phase compensated. The compensation capacitor, C_c , is connected between pins 4 and 5. The compensation capacitor must be an NPO type capacitor rated for the full supply voltage (150V). On page 2, under Amplifier Pinout and Connections, you will find a table that gives recommended compensation capacitance value for various circuit gains and the resulting slew rate for each capacitor value. Consult also the small signal response and phase response plots for the selected compensation value in the Typical Performance Graphs section. A compensation capacitor less than 100pF is not recommended.

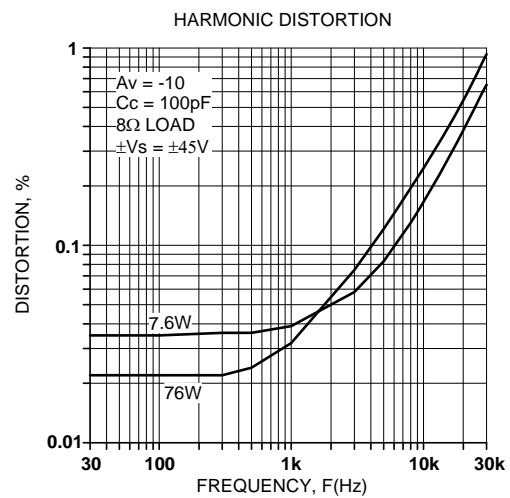
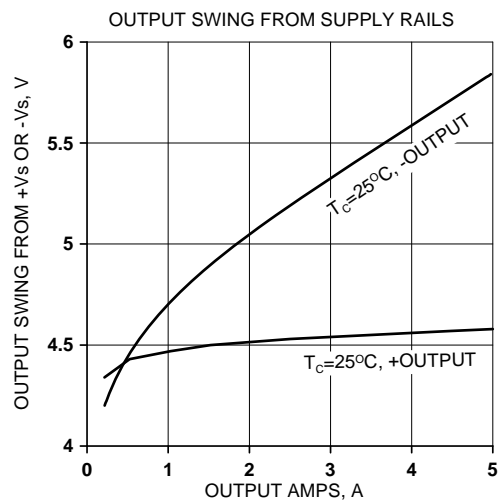
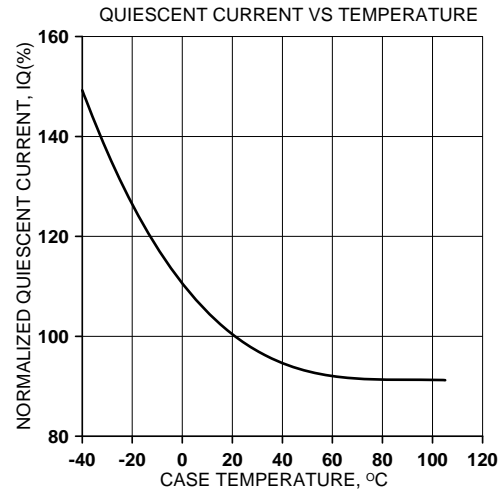
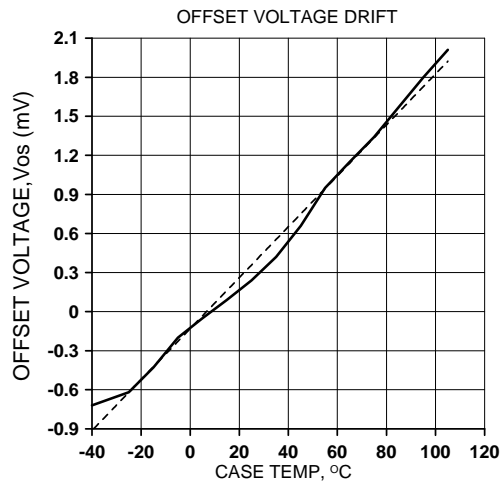
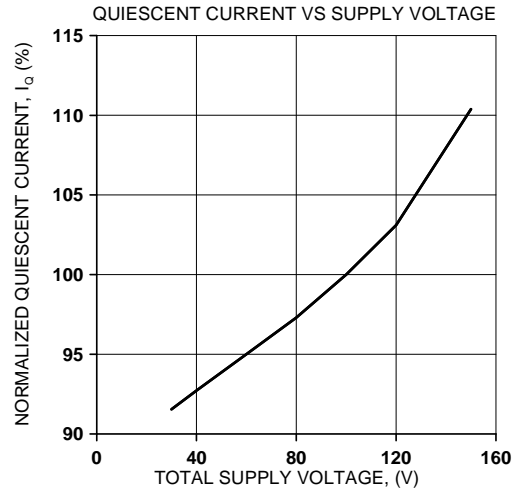
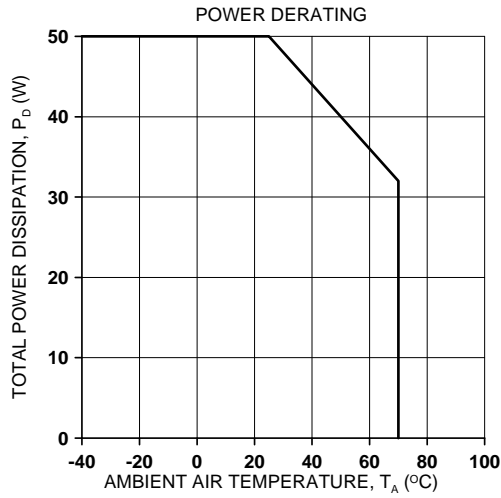

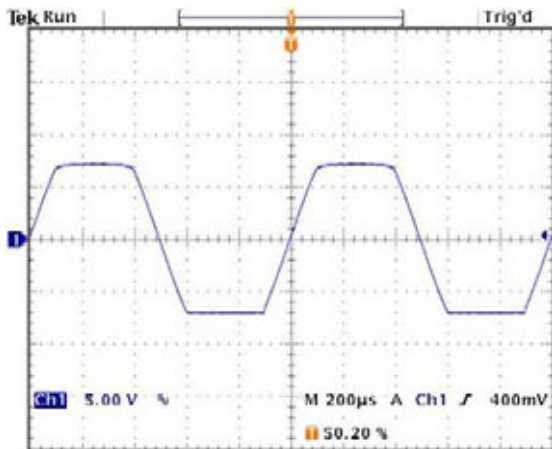
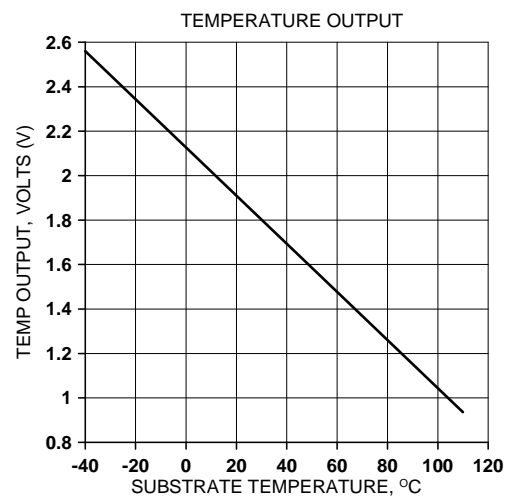
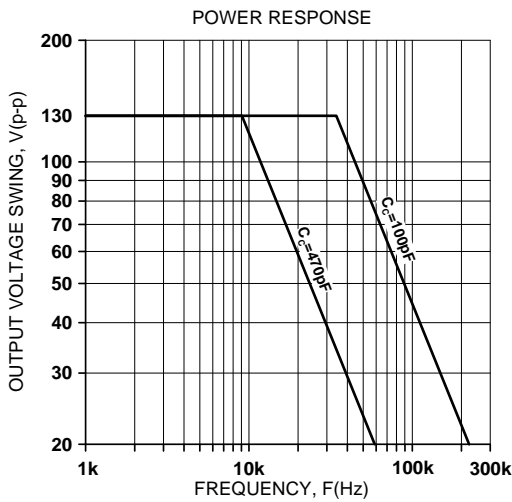
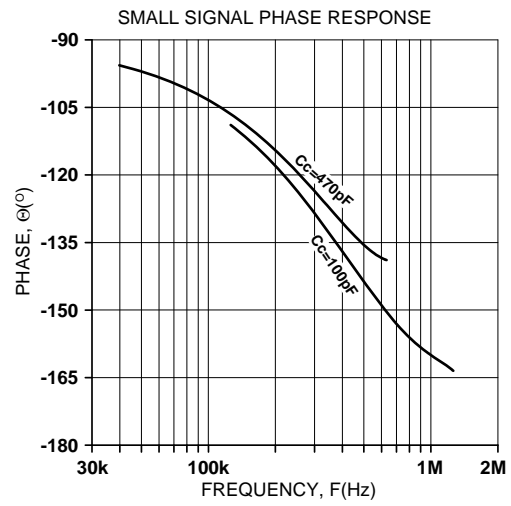
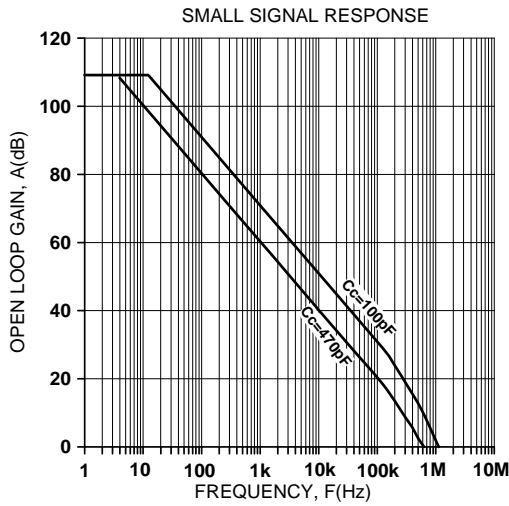

1kHz sine clipped by current limit into 100 Ω load

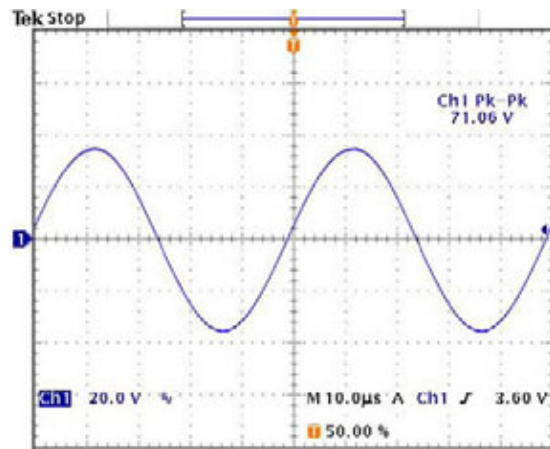

20kHz sine into 8 Ω load, $G=-10, C_c=100pF$

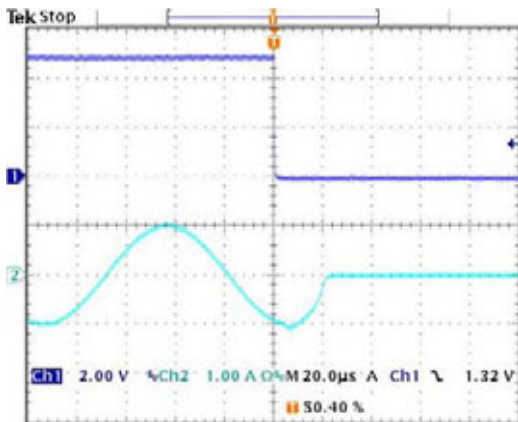

SHUTDOWN RESPONSE, NEGATIVE OUTPUT TO ZERO TRANSITION

The oscilloscope display at the left shows a view of a 10kHz 2A p-p amplifier output signal being interrupted near the negative peak by a shutdown signal on Ch1. The Ch2 display shows the output *current* going to zero about 20µS after the shutdown signal goes low.

SHUTDOWN RESPONSE, POSITIVE OUTPUT TO ZERO TRANSITION

The oscilloscope display at the right shows a view of a 10kHz 2A p-p amplifier output signal being interrupted near the positive peak by a shutdown signal on Ch1. The Ch2 display shows the output *current* going to zero about 20µS after the shutdown signal goes low.

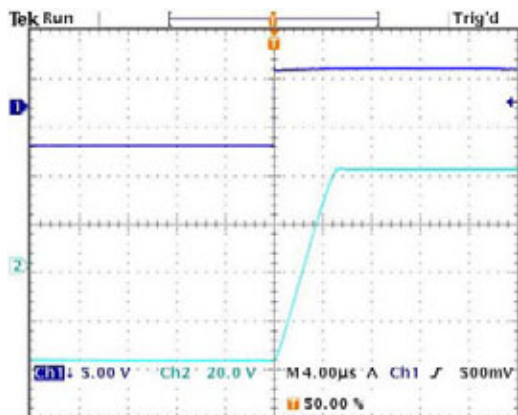
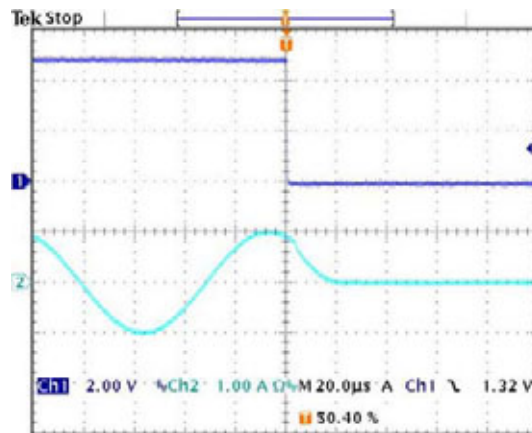

Pulse Response, Negative to Positive, 250Ω Load
G=-10, Cc=100pF

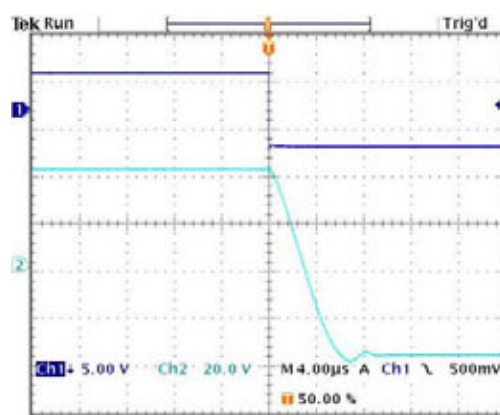

Pulse Response, Positive to Negative, 250Ω Load
G=-10, Cc=100pF

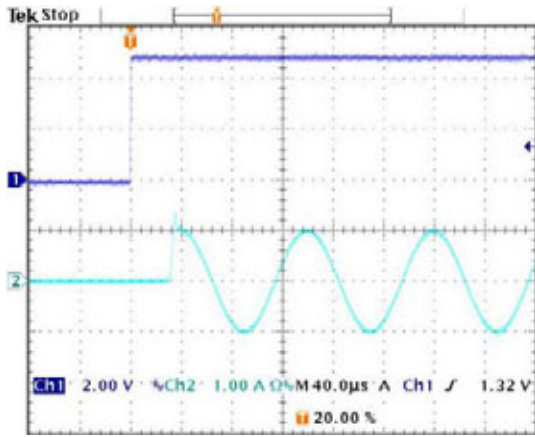

SHUTDOWN RECOVERY TO POSITIVE OUTPUT TRANSITION

The oscilloscope display at the left shows a view of a 10kHz, 2A p-p amplifier output signal on Ch2 recovering from a shutdown signal on Ch1 (high on Ch1 means **not** shutdown). The output recovers to its expected output near the positive peak after about 40µS.

SHUTDOWN RECOVERY TO NEGATIVE OUTPUT TRANSITION

The oscilloscope display at the left shows a view of a 10kHz, 2A p-p amplifier output signal on Ch2 recovering from a shutdown signal on Ch1 (high on Ch1 means **not** shutdown). The output recovers to its expected output near the negative peak in less than 40µS.

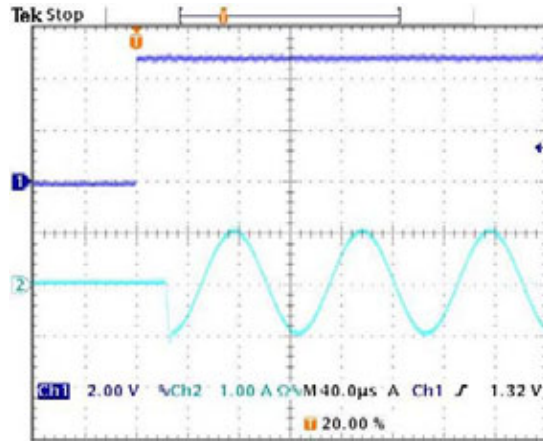

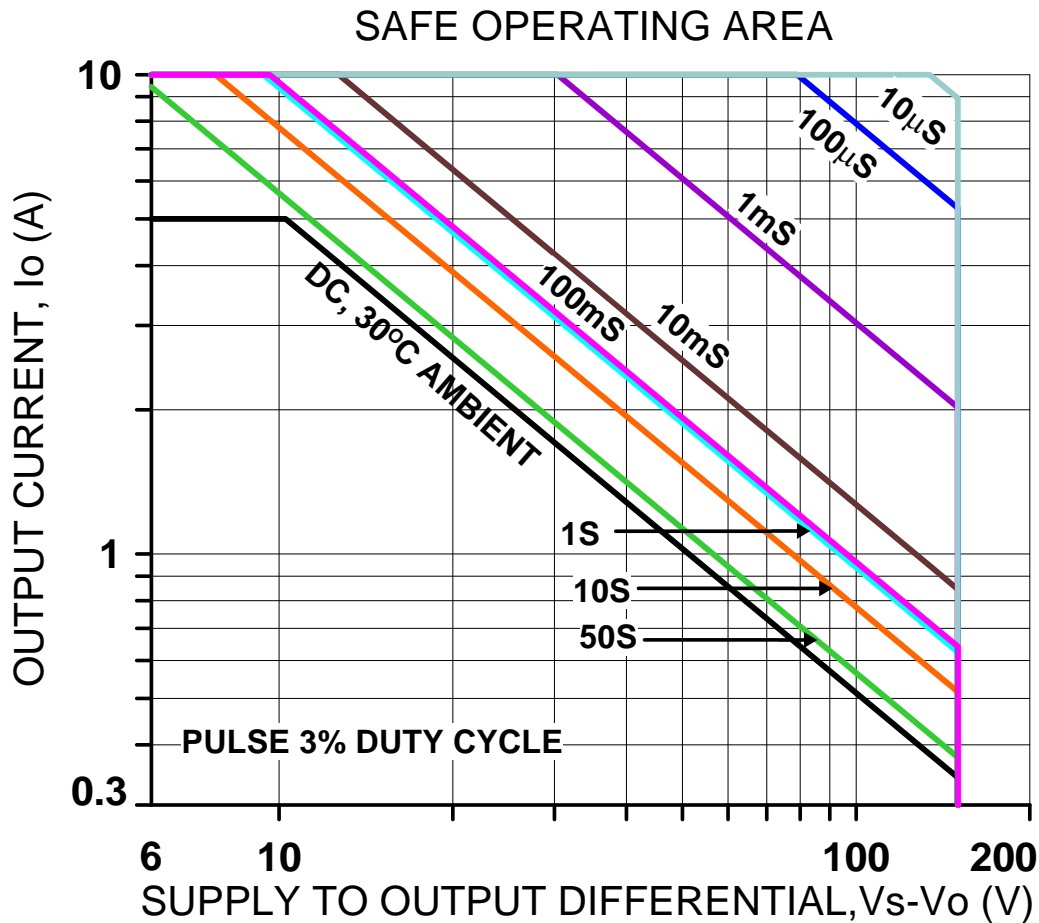

SAFE OPERATING AREA

The safe operating area (SOA) of a power amplifier is its single most important specification. The SOA graph presented above serves as a first approximation to help you decide if the PAD112 will meet the demands of your application. But a more accurate determination can be reached by making use of the **PAD Power™** spreadsheet which can be found in the *Power Amp Design* website under *Design Spreadsheet* tab. While the graph above adequately shows DC SOA and some pulse information it does not take into account ambient temperatures higher than 30°C, AC sine, phase or non-symmetric conditions that often appear in real-world applications. The **PAD Power™** spreadsheet takes all of these effects into account.

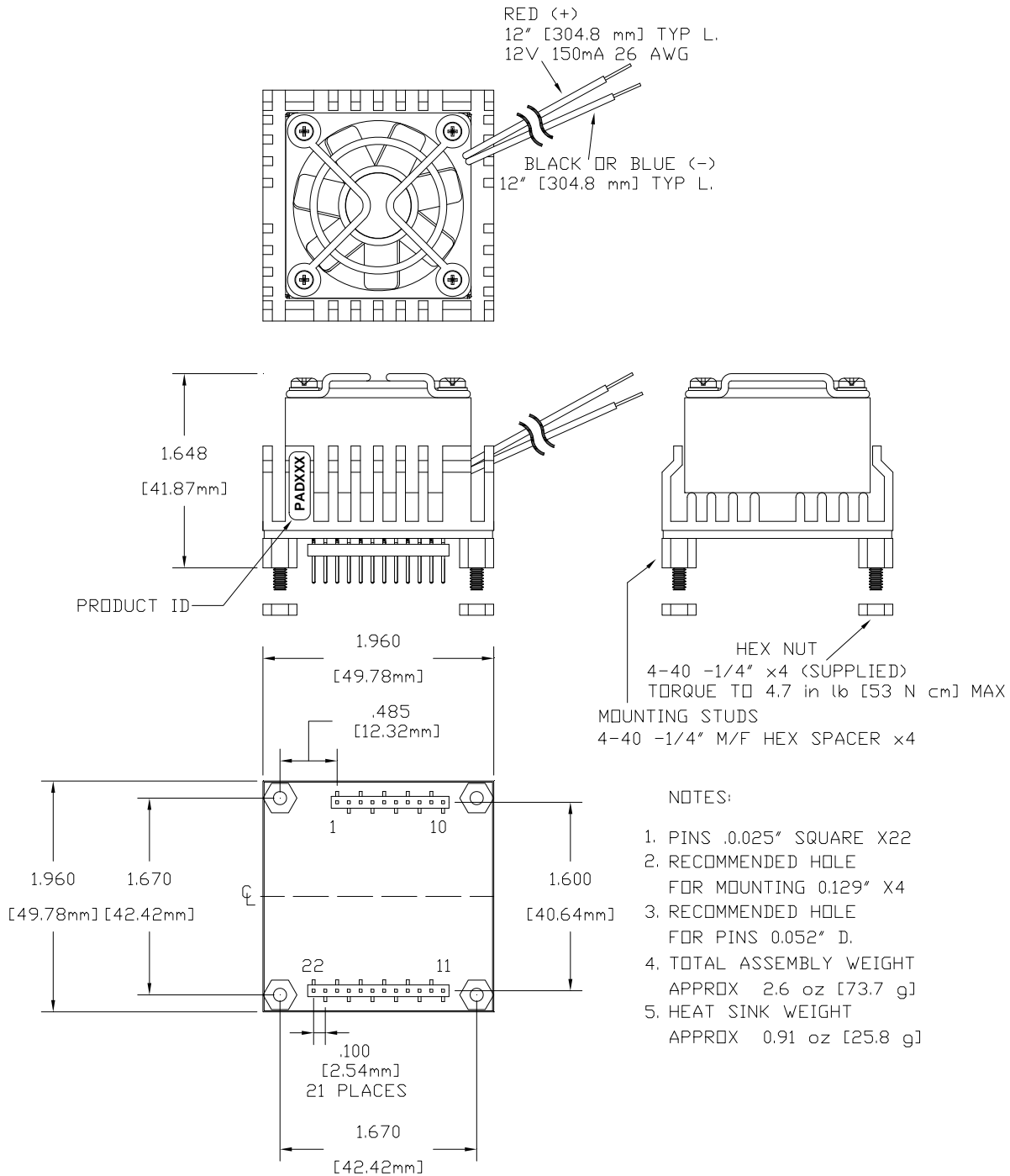

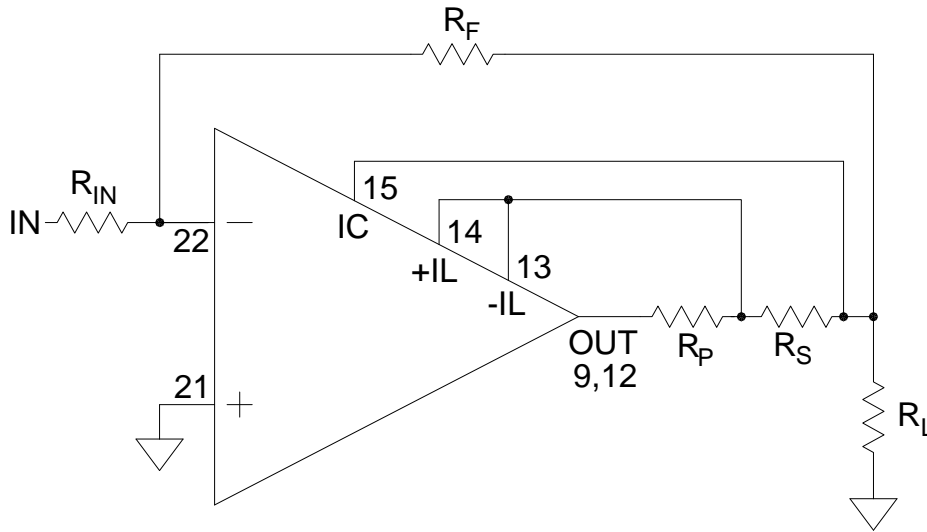

FIGURE 1.
4-WIRE CURRENT LIMIT

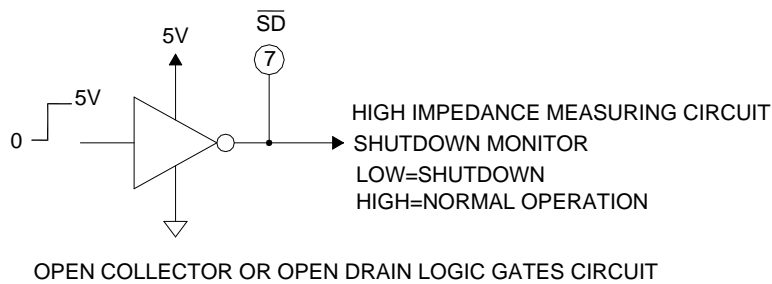
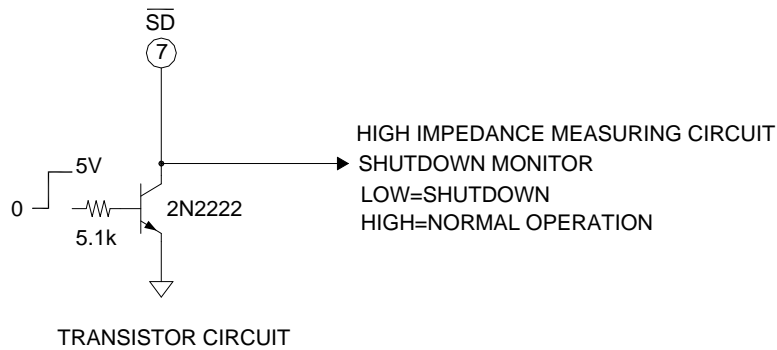

FIGURE 2.
EXTERNAL SHUTDOWN WITH MONITOR

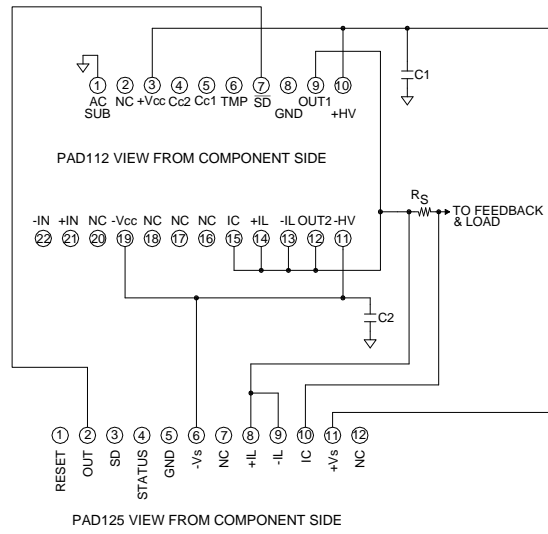

FIGURE 4
TYPICAL PAD112 CONNECTIONS TO PAD125 ACCESSORY MODULE

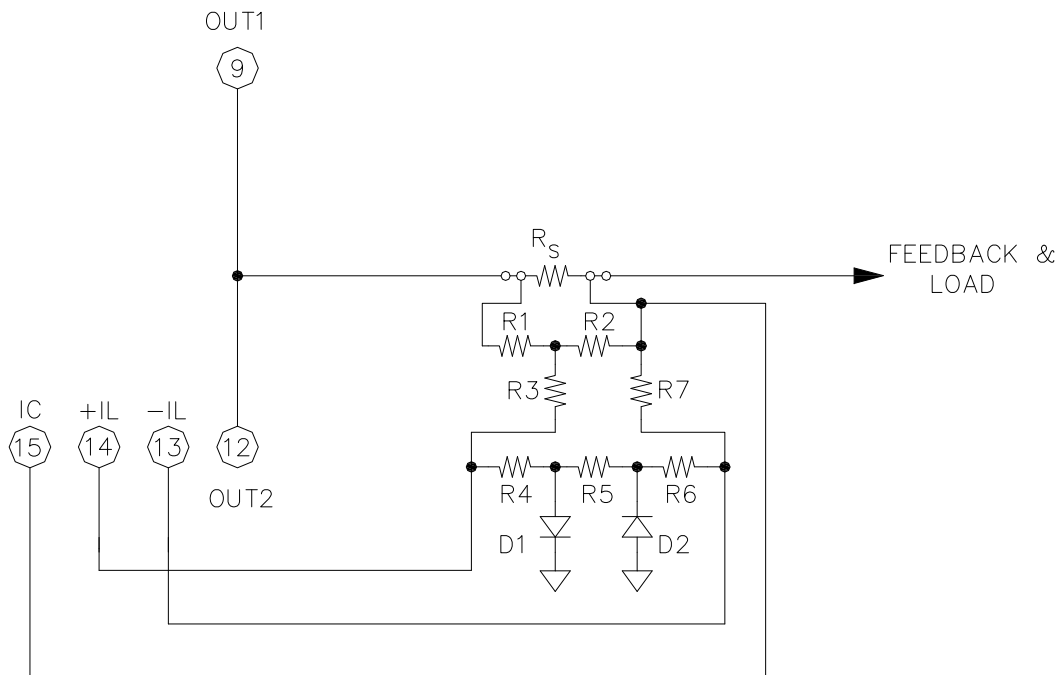

FIGURE 5
DUAL SLOPE (FOLD-OVER) CURRENT LIMIT

With the three current limit function pins (pins 13-15) dual slope current limiting can be implemented that more closely approximates the SOA curve of the amplifier than can be achieved with standard current limiting techniques. Values for resistors R1-R7 and R_S can be calculated using the **PAD Power**[™] spreadsheet that can be downloaded from the Power Amp Design web site. Fold-over current limit can also be achieved when using the PAD123 Current Limit Accessory Module. See the datasheet for the PAD123 for further details.