

PowerAmp Design

COMPACT POWER OP AMP

PAD541

Rev D

KEY FEATURES

- **LOW COST**
- **HIGH VOLTAGE – 100 VOLTS**
- **HIGH OUTPUT CURRENT – 5 AMPS**
- **50 WATT DISSIPATION CAPABILITY**
- **100 WATT OUTPUT CAPABILITY**
- **0.63” HEIGHT SIP DESIGN**

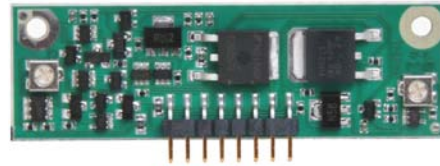

PAD541

APPLICATIONS

- **LINEAR MOTOR DRIVE**
- **HIGH VOLTAGE INSTRUMENTATION**
- **SEMICONDUCTOR TESTING**
- **TEST EQUIPMENT**

DESCRIPTION

The PAD541 compact operational amplifier is constructed with surface mount components to provide a cost effective solution for many industrial applications. The SIP design is only 0.63” high and provides clearance for those applications where circuit boards are mounted side by side in a card cage. The PAD541 exceeds the performance of monolithic amplifiers while having a similar height dimension. User selectable external compensation tailors the amplifier’s response to the application requirements. Programmable current limit is built-in. The amplifier circuitry is built on a thermally conductive but electrically insulating substrate. No BeO is used in the PAD541. The resulting module is a small, high performance turn-key solution for many industrial applications.

PowerAmp Design ♦ PAD541 ♦ COMPACT POWER OP AMP

EQUIVALENT CIRCUIT

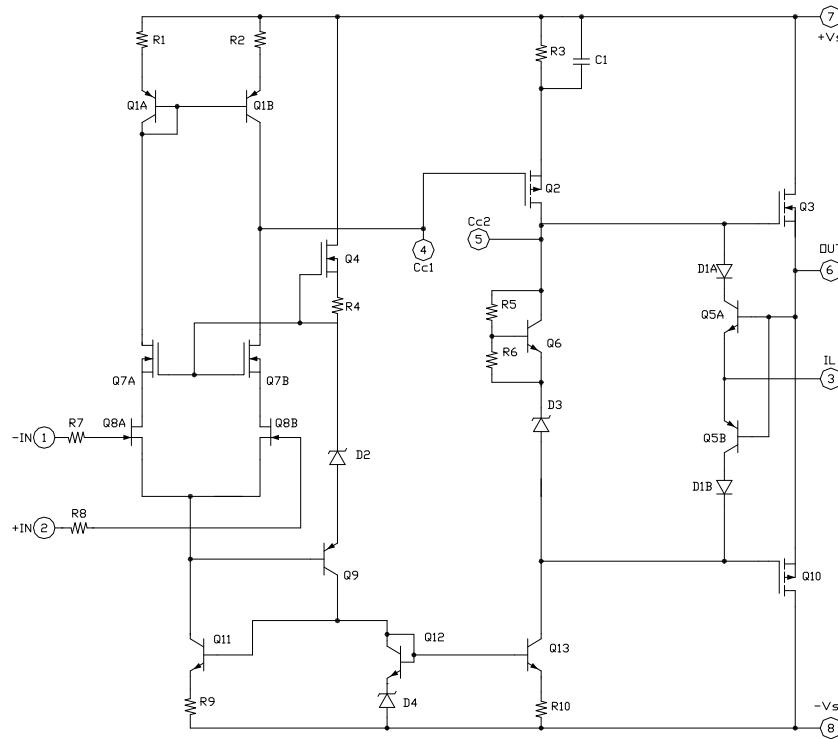

PINOUT & CONNECTIONS

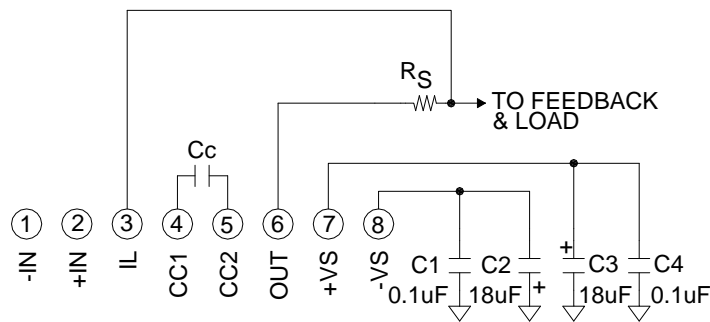

PAD541 VIEW FROM COMPONENT SIDE

PHASE COMPENSATION		
GAIN	Cc	SLEW V/uS
1	220pF	4
≥ 3	100pF	10
≥ 10	47pF	14

ABSOLUTE MAXIMUM RATINGS			
SUPPLY VOLTAGE, +Vs to -Vs	100V	INPUT VOLTAGE	+Vs to -Vs
OUTPUT CURRENT, peak	7A, within SOA	DIFFERENTIAL INPUT VOLTAGE	± 20V
POWER DISSIPATION, internal, DC	50W	TEMPERATURE, pin solder, 10s	300°C
TEMPERATURE, junction ²	150°C	TEMPERATURE RANGE, storage	-40 to 105°C
		OPERATING TEMPERATURE, case	-40 to 105°C

PARAMETER	TEST CONDITIONS ¹	MIN	TYP	MAX	UNITS
INPUT					
OFFSET VOLTAGE			1	3	mV
OFFSET VOLTAGE vs. temperature	Full temperature range		20	50	μV/°C
OFFSET VOLTAGE vs. supply				20	μV/V
BIAS CURRENT, initial ³				100	pA
BIAS CURRENT vs. supply				0.1	pA/V
OFFSET CURRENT, initial				50	pA
INPUT RESISTANCE, DC			100		G Ω
INPUT CAPACITANCE			4		pF
COMMON MODE VOLTAGE RANGE				+Vs-10	V
COMMON MODE VOLTAGE RANGE			-Vs+0	-Vs+1.5	V
COMMON MODE REJECTION, DC		110	128		dB
NOISE	100kHz bandwidth, 1kΩ R _s		10		μV RMS
GAIN					
OPEN LOOP	R _L = 10kΩ, C _C =100pF	108			dB
GAIN BANDWIDTH PRODUCT @ 1MHz	C _C =100pF		2		MHz
PHASE MARGIN	Full temperature range	45			degree
OUTPUT					
VOLTAGE SWING	I _O = 5A	+Vs-7	+Vs-6		V
VOLTAGE SWING	I _O = -5A	-Vs+7	-Vs+6		V
CURRENT, continuous, DC				5	A
SLEW RATE, A _v = -10	C _C = 100pF	10	12		V/μS
SETTLING TIME, to 0.1%	2V Step, C _C = 100pF		6		μS
RESISTANCE	No load, DC		8		Ω
POWER SUPPLY					
VOLTAGE		± 10	± 40	± 50	V
CURRENT, quiescent			15	17	mA
THERMAL					
RESISTANCE, AC, junction to case ⁵	Full temperature range, f ≥ 60Hz			2.3	°C/W
RESISTANCE, DC junction to case	Full temperature range			2.5	°C/W
TEMPERATURE RANGE, case		-40		105	°C

NOTES:

1. Unless otherwise noted: T_C = 25°C, compensation C_C = 470pF, DC input specifications are ± value given, power supply voltage is typical rating.
2. Derate internal power dissipation to achieve high MTBF.
3. Doubles for every 10°C of case temperature increase.
4. +Vs and -Vs denote the positive and negative supply voltages.
5. Rating applies if the output current alternates between both output transistors at a rate faster than 60Hz.

SAFETY FIRST

The operating voltages of the PAD541 are potentially deadly. When developing an application circuit it is wise to begin with power supply voltages as low as possible while checking for circuit functionality. Increase supply voltages slowly as confidence in the application circuit increases. Always use a “hands off” method whereby test equipment probes are attached only when power is off.

CURRENT LIMIT

The current limiting function of the PAD541 is externally programmable. See Figure 1. The sense voltage for current limit is 0.65V. Thus:

$$I_L = \frac{0.65V}{R_S}$$

Where I_L is the value of the limited current and R_S is the value of the current limit sense resistor.

In addition, the sense voltage has a temperature coefficient approximately equal to $-2.2\text{mV}/^\circ\text{C}$ case temperature.

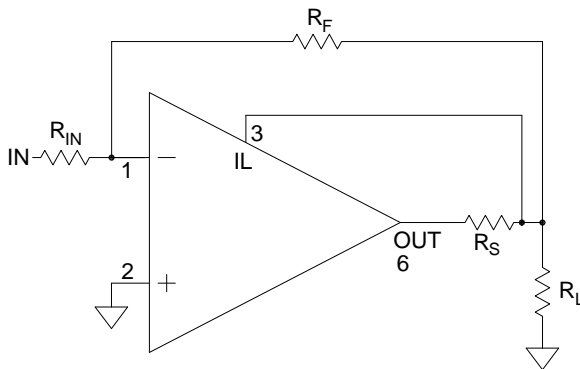

Figure 1

MOUNTING THE AMPLIFIER

In most applications the amplifier must be attached to a heat sink. Spread a thin and even coat of heat sink grease across the back of the PAD541 and also the heat sink where the amplifier is to be mounted. Push the amplifier into the heat sink grease on the heat sink while slightly twisting the amplifier back and forth a few times to bed the amplifier into the heat sink grease. On the final twist align the mounting holes of the amplifier with the mounting holes in the heat sink and finish the mounting using 2-56 screw and a #2 stainless steel internal tooth lock washer. The lock washer helps to electrically connect the substrate to the heat sink (that should be grounded). Torque the screws to 2.2 in-pound (0.248 N meter) maximum. Do not rely on the screw pressure to squeeze out any excess heat sink grease as this will likely only bend the substrate at the

corners. See “**Dimensional Information**” for a detailed drawing. It is recommended that the heat sink be grounded to the system ground.

PHASE COMPENSATION

The PAD541 **must** be phase compensated. The compensation capacitor, C_C , is connected between pins 4 and 5. The compensation capacitor must be an NPO type capacitor rated for the full supply voltage (100V). On page 2, under Amplifier Pinout and Connections, you will find a table that gives recommended compensation capacitance value for various circuit gains and the resulting slew rate for each capacitor value. Consult also the small signal response and phase response plots for the selected compensation value in the Typical Performance Graphs section. A compensation capacitor less than 47pF is not recommended.

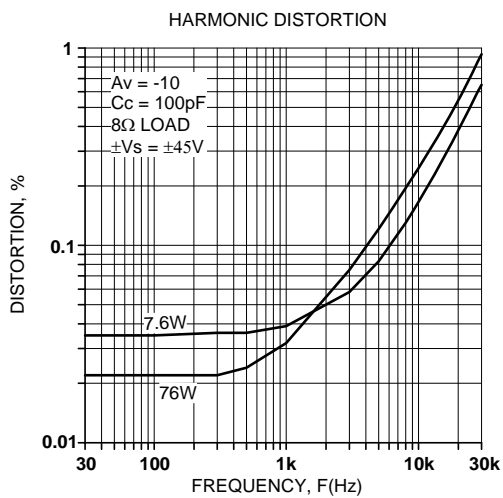
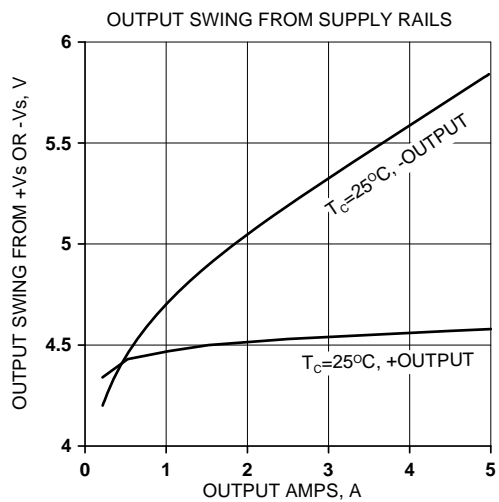
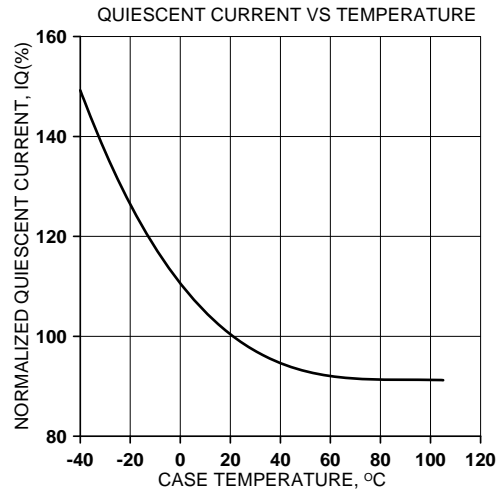
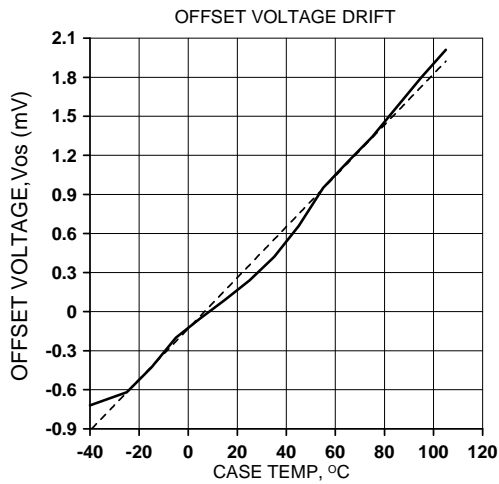
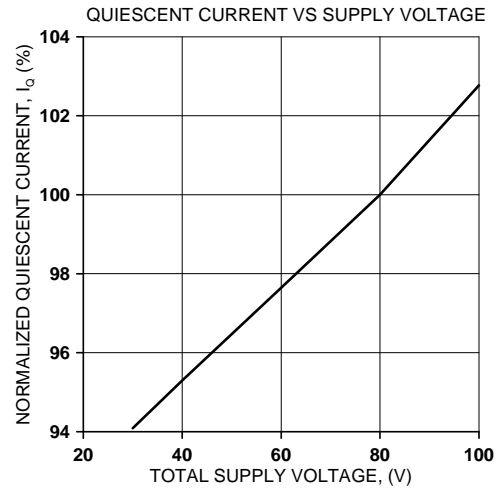
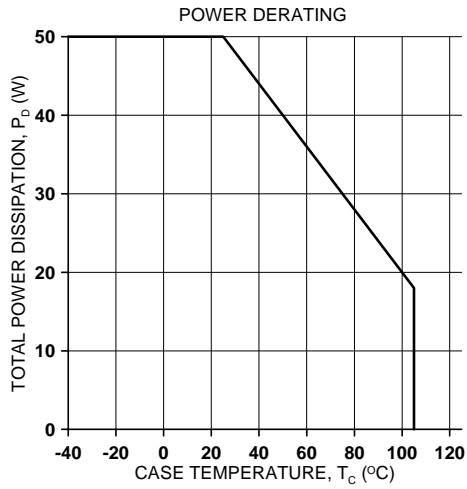

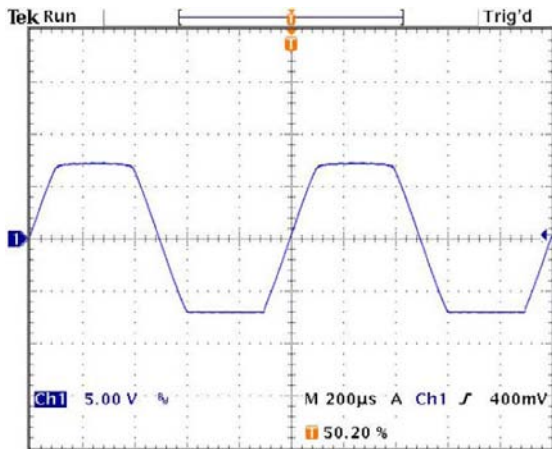
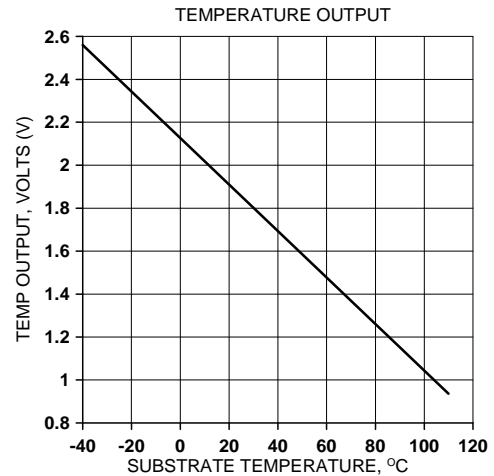
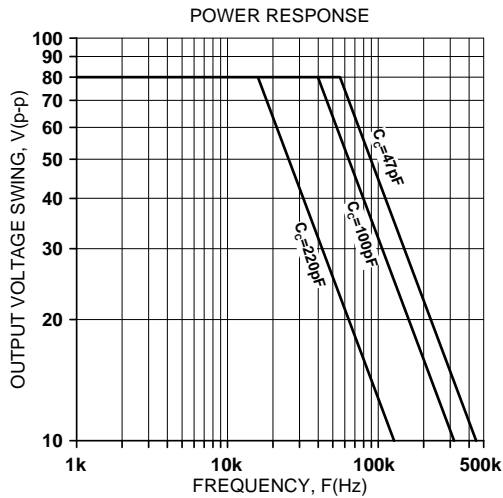
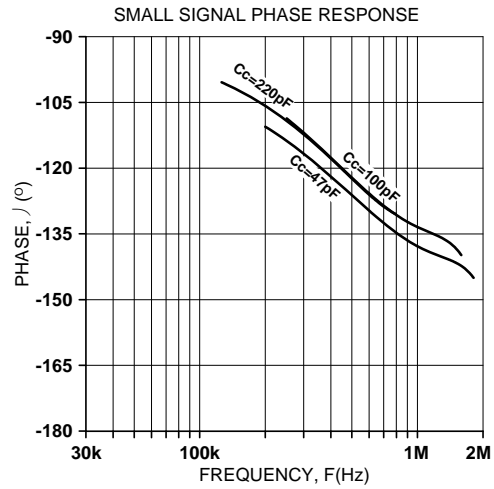
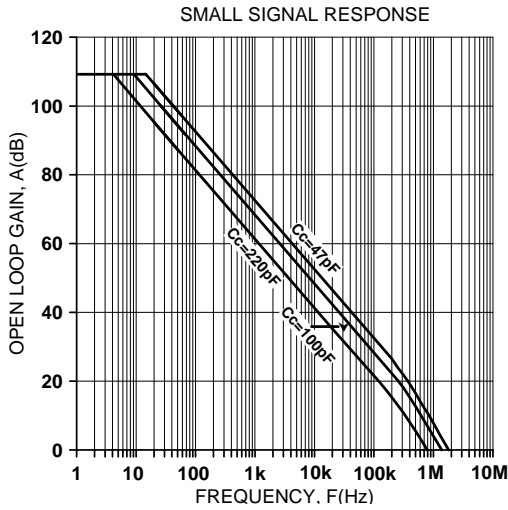

1kHz sine clipped by current limit into 100 Ω load

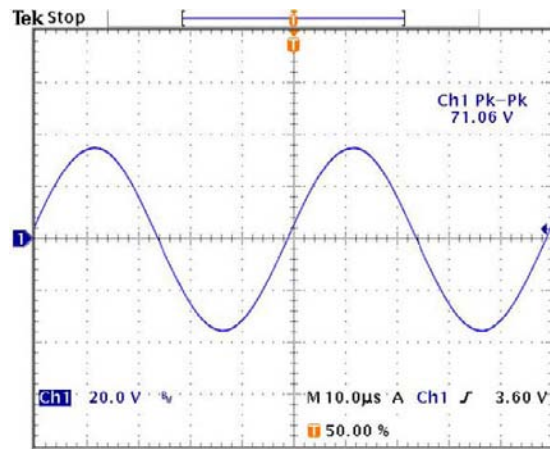

20kHz sine into 8 Ω load, $G = -10$, $C_c = 100pF$

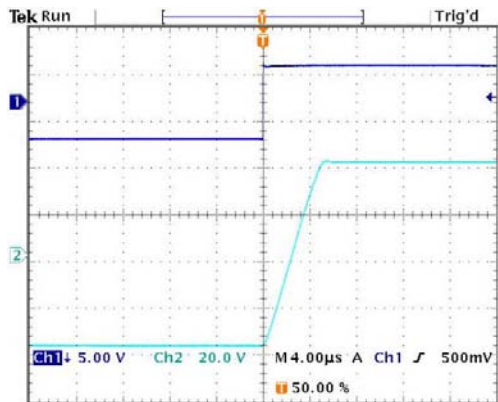

Pulse Response, Negative to Positive, 250Ω Load
G=-10, Cc=100pF

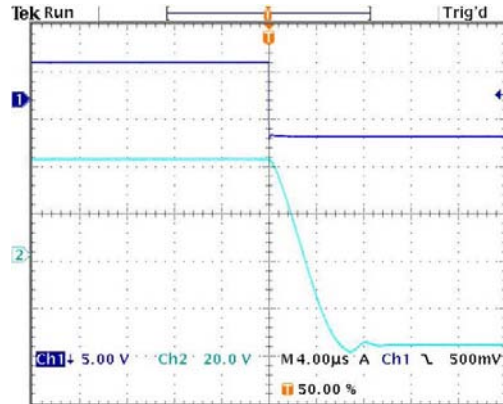

Pulse Response, Positive to Negative, 250Ω Load
G=-10, Cc=100pF

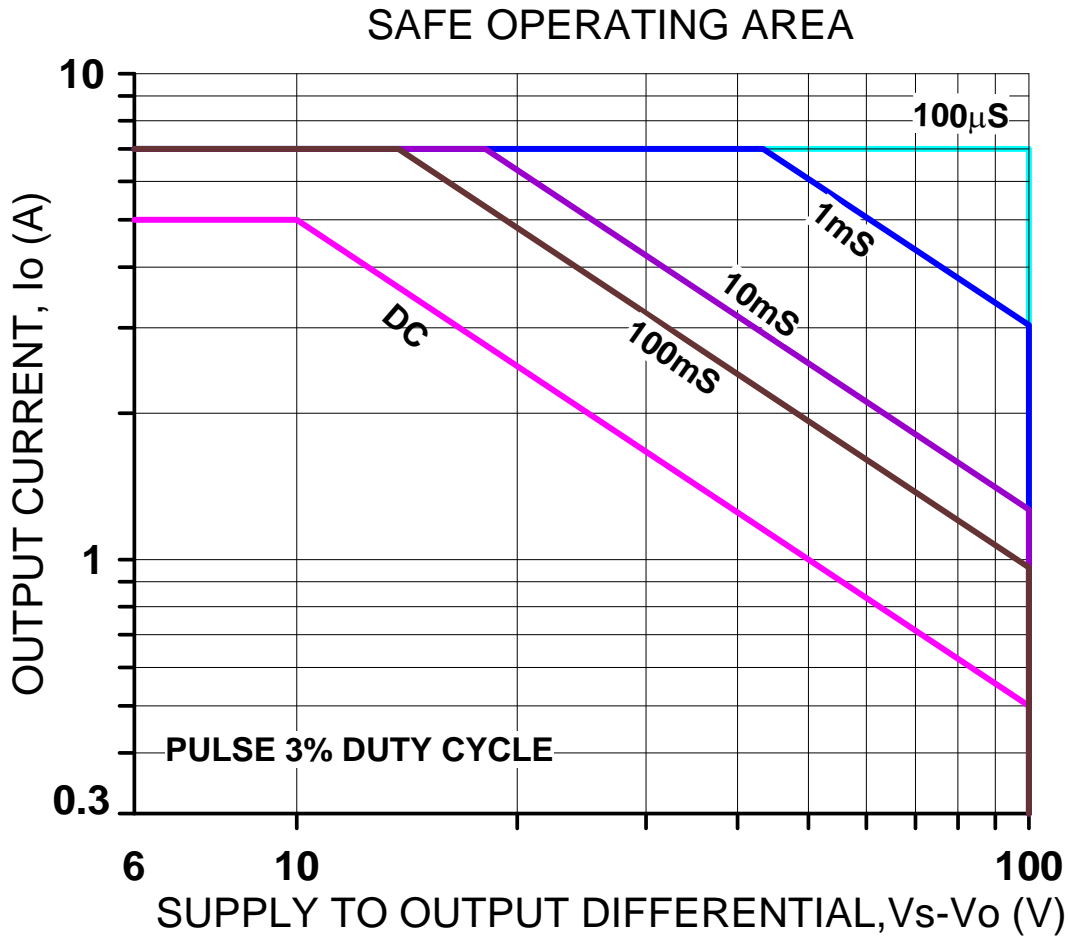

SAFE OPERATING AREA

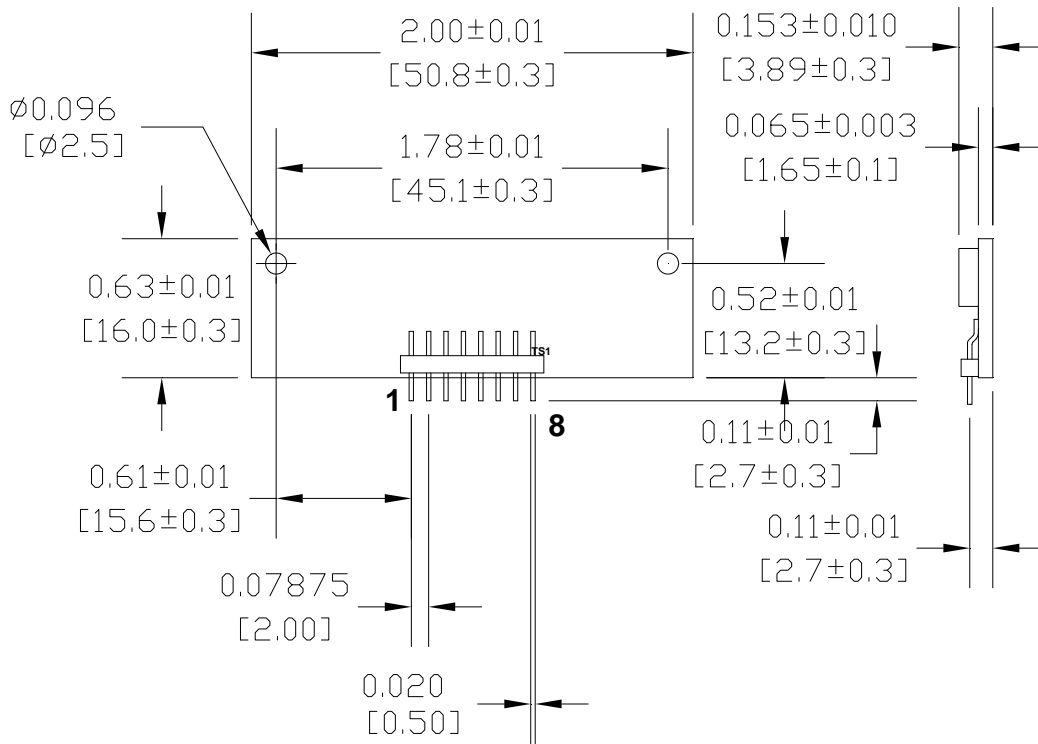

NOTES:

1. PINS 0.020" SQUARE X8
2. RECOMMENDED HOLE FOR PINS 0.035" D.
3. TOTAL WEIGHT APPROX 0.17 oz [4.8 g]

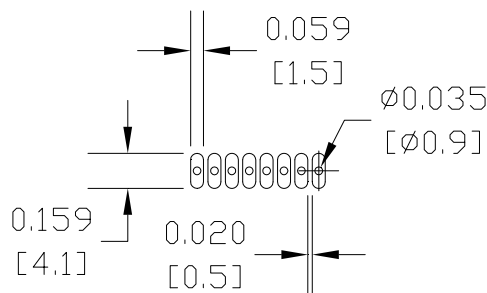
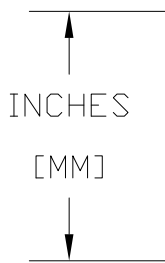

SUGGESTED PAD LAYOUT DESIGN

PowerAmp Design ♦ PAD541 ♦ COMPACT POWER OP AMP