

# PowerAmp Design

EVALUATION KIT FOR PAD127

EVAL127

Rev F

## INTRODUCTION

The EVAL127 assembled evaluation kit provides a convenient method to become familiar with the operation of the PAD127 operational amplifier before your application circuit is committed to production. Some assembly is required since some user selections are needed depending on the application. For example, a current limit resistor value needs to be selected by the user. Also, there are several PCB mounting options available. The amplifier and accessory modules are purchased separately.

Critical connections for power supply bypassing and compensation are pre-wired. Connections are also provided for implementing fold-over current limit as well as standard current limit with the optional PAD125 Current Limit Accessory Module. Fold-over current limit components are not provided since each application will have different requirements. Diode clamps on each power supply and the output connections are provided for those applications in which significant inductive kickback may be found. Terminal strips are also provided for input and output signals and power.

## ASSEMBLY STEPS

*Please note that the #1 cause of problems for evaluation kit users is not reading and following the directions (all of them). The #2 cause of problems is poor solder joints (cold or bridging). Don't become a statistic. ✓ each step.*

Refer to the Illustrated Parts List for the components mentioned in each assembly step. Some steps may require a soldering temperature higher than normal and/or a larger soldering iron tip. These steps are marked with an \*.

□ 1. Notice that the printed circuit board (PCB) is labeled on one side as the "DUT SIDE" and the other side as "CIRCUIT SIDE".

□ 2. As shown in the illustrated parts list, one or more of PAD's accessory cage jack strip CJS01 was used in the assembly of this kit. It may be advisable to use the cage jack strips in your production circuit board as well. The CJS01 cage jack sockets provide a convenient and inexpensive socket. Soldering and/or de-soldering the amplifier from the circuit board can be extremely difficult due to the high thermal conductivity of the amplifier's pins and substrate. You can find the datasheet for the CJS01 on the PAD website under the "Accessory Modules" tab.

□ 3. Refer to "Jumper Selection" below the Circuit Diagram for the EVAL127 on page 4. Install the required jumpers at the locations indicated depending on the options you have chosen. Refer to the data sheet for the PAD125 for complete information on current limit options.



Assembled EVAL127 with PAD127 mounted.  
Optional PAD125 and PAD131 also shown.

□ 4.\* This step may require a soldering temperature higher than normal and/or a larger soldering iron tip. Four current limiting sense resistors,  $R_S$ , are provided; one 0.005 $\Omega$ , one 0.010 $\Omega$ , one 0.050 $\Omega$  and one 0.100 $\Omega$ . Refer to the datasheets for the PAD127 and PAD125 to determine which resistor value best fits your application. Smear a small amount of heat sink grease on the back of the selected resistor and then attach the resistor to the heat sink HS1 at  $R_S$  with a 4-40 X 1/2" screw and nut. The plastic nut driver supplied with this kit will help here. Tighten the 4-40 resistor mounting hardware. Solder the resistor from the "CIRCUIT SIDE" of the PCB making sure that the holes are completely filled with solder.

□ 5.\* Refer the page 5 of the datasheet for the PAD127 to select a value for the six degeneration resistors  $R_{D1}$ - $R_{D6}$ . Values supplied with this kit are listed in the illustrated parts list. Install  $R_{D1}$ - $R_{D6}$  from the "CIRCUIT SIDE" of the PCB, leaving a small gap between the body of the resistors and the circuit board, and solder from the "DUT SIDE" of the PCB,. Cut off the excess resistor lead lengths. Make doubly sure that all the degeneration resistors are the same value and the proper value for your application.

□ 6. D3 and D5 are transient voltage suppressor diodes and are not supplied since the type (breakdown voltage) varies with the application. They are not necessary for every application. They are most commonly used in application circuits where kickback from the load may force the supply voltage above the limits of the amplifier.

□ **7.** The evaluation kit PCB can be mounted in several ways. **Option 1- Chassis mount.** Use #6 x 1/4" M/F hex standoffs, #6 X 1/4" screw and #6 nut (not supplied) attached to the PCB at the four corners of the PCB and the chassis. Use one of the rubber bumpers supplied at the indicated place at the center of the amplifier on the "CIRCUIT SIDE" of the PCB.

**Option 2- Bench-top mount.** Use the five rubber bumpers supplied. These are "stick-on" components. Remove the release paper from each bumper and apply the bumper to the square outlines on the "CIRCUIT SIDE" of the PCB.

**Option 3- DIN rail mount.** The PCB can be mounted on two DIN rails. Press the plastic DIN rail adaptors into the PCB in the holes at the edges of the PCB at locations 1 through 4 from the "CIRCUIT SIDE" of the PCB. Make sure that the plastic tines have fully spread out on the "DUT SIDE" of the PCB. The center to center dimension of the DIN rails is to be 4.30" [109.2mm].

□ **8.** Components for locations R1-R7, D1, D2 are for the optional fold-over current limiting and are not supplied. Refer to the data sheet of the PAD127 to find out how to apply circuits that require these components.

□ **9.** Remove the 4 hex nuts from the mounting spacers of the PAD127.

□ **10.** Align the 4 studs of the mounting spacers with the mounting holes in the PCB. Be sure that the amplifier's pin 1 aligns with pin 1 on the PCB. Slowly lower the amplifier into the PCB, making sure that the pins of the amplifier and the cage jacks mate. Push the amplifier into the PCB until the mounting spacers meet the PCB.

□ **11.** Fasten the amplifier to the PCB with the 4 hex nuts previously removed. Do not over-tighten the nuts as this may strip the mounting studs. The provided plastic nut starter can assist you here.

□ **12.** Strip 1/8" of insulation from the wires connected to the fan. Twist and tin the wire ends (this may already be done). Insert the red wire into the cage jack labeled "+" and the black or blue wire into the jack marked "-" at the location marked "FAN". Or, if you plan to use the PAD131 Fan Controller Accessory Module, insert the fan wires similarly into the "+" and "-" cage jacks at the location marked "Fan Control". Do not solder the fan wires into the sockets.

□ **13.** Add components as necessary to evaluate your application circuit. You can utilize the evaluation kit schematic and PCB views to map out your circuit and components. **Remember, if you are using the PAD125 (PAD125 replaces the PAD121) Current Limit Accessory Module additional components will be needed to program the operation of the module. See the PAD125 datasheet.**

□ **14.** The PAD127 **must** be compensated to operate correctly. See EXTERNAL CONNECTIONS DIAGRAM on page 2 of the datasheet for the PAD127. A table is provided relating the

required compensation capacitor value for various circuit gains. Your selected phase compensation capacitor will be installed at "C<sub>c</sub>" on the evaluation kit PCB. A 470 pF compensation capacitor has already been installed in the kit, but this value may not be the best value for your application. A 100pF capacitor is also provided. Remove and replace the capacitor as necessary.











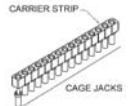



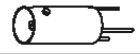

□ **15.** If you have chosen to use the PAD125 accessory module install it at this time making sure that pin 1 on the module is aligned with the pin 1 marking on the PCB.

□ **16.** If you have chosen to use the PAD131 Fan Controller Accessory Module install it at this time making sure that pin 1 on the module is aligned with the pin 1 marking on the PCB. Double check that the wires from the fan are inserted into the jacks marked "Fan Control".

□ **17.** The evaluation kit assembly is complete. Be sure you have read and followed all the assembly steps. Do not forget any jumpers that need to be installed. Inspect the circuit board for solder shorts or poor solder joints. An illuminated magnifier is helpful.

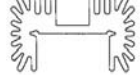
□ **18. Before applying power to your circuit set the power supply for ±20V and set the power supply current limit to approximately 100mA. Use little or no load at first. Apply an input signal and check the output with an oscilloscope to verify proper functionality. This step can prevent damaging the amplifier or the circuit board should there be some mistake in assembly.**

*Note that the PAD127, PAD125 and PAD131 are purchased separately.*

✓	Ref	Qty	Description	Mfg/Distributor	Mfg. Part Number	Illustration (not to scale)
<input type="checkbox"/>	Amplifier Pins 1-46 + TPs	3	Cage Jacks w/carrier strip 32 wide	Power Amp Design	CJS01	
<input type="checkbox"/>	C1, 2	2	Chip Capacitor, 1uF	Novacap	1825B105K201N	
<input type="checkbox"/>	C5,6	2	35V Electrolytic Capacitor, 47uF	Panasonic/Digi-Key	EEU-FC1V470	
<input type="checkbox"/>	C3, 4	2	100V Electrolytic Capacitor, 2700uF	Panasonic/Digi-Key	ECOS2HP272CA	
<input type="checkbox"/>	C <sub>c</sub>	1	Ceramic Capacitor, 100pF	Kemet/Mouser	C322C101J2G5HA	
<input type="checkbox"/>	C <sub>c</sub>	1	Ceramic Capacitor, 470pF	Kemet/Mouser	C322C471J2G5HA	
<input type="checkbox"/>	JP1	1	BNC Jack	AMP/Digi-Key	5221123-2	
<input type="checkbox"/>	JP2	1	Terminal Block	Phoenix/Digi-Key	1729157	
<input type="checkbox"/>	TS1	1	Terminal Strip	Molex/Newark	38660-7807	
<input type="checkbox"/>	R <sub>s</sub>	4	Sense Resistor	Isotek Isotek Isotek Isotek	PBV-R050-1.0 (50mΩ) PBV-R100-1.0 (100mΩ) PBV-R005-1.0 (5mΩ) PBV-R010-1.0 (10 mΩ)	
<input type="checkbox"/>	R <sub>D1</sub> - R <sub>D6</sub>	42	Degeneration Resistor, 6 ea., 7 values	Vishay/Mouser Vishay/Mouser Vishay/Mouser Vishay/Mouser Vishay/Mouser Vishay/Mouser Vishay/Mouser	RS02BR3000F (300mΩ) RS02BR2500F (250mΩ) RS02BR2000F (200mΩ) RS02BR1500F (150mΩ) RS02BR1000F (100mΩ) LVR05R0500F (50mΩ) LVR05R0300F (30mΩ)	
<input type="checkbox"/>	D4, 6	2	Diode, Fast Recovery	ON Semi/Digi-Key	MUR460RL	
<input type="checkbox"/>	NA	5	Rubber Bumper	3M/Digi-Key	SJ5518	
<input type="checkbox"/>	HS1	1	Heat Sink	Wakefield/Online Components	67725ABP	
<input type="checkbox"/>	NA	1	Nut Starter	Menda/Jensen Tool	200	
<input type="checkbox"/>	NA	1	Heak Sink Grease	NTE/Jameco	NTE303	
<input type="checkbox"/>	NA	1	4-40X1/2" screw & 4-40 nut	NA	NA	
<input type="checkbox"/>	NA	4	35mm DIN Rail Adaptor	Scidyne	121-0014	
<input type="checkbox"/>	NA	1	PCB	Power Amp Design	EVAL127	NA

CIRCUIT DIAGRAM

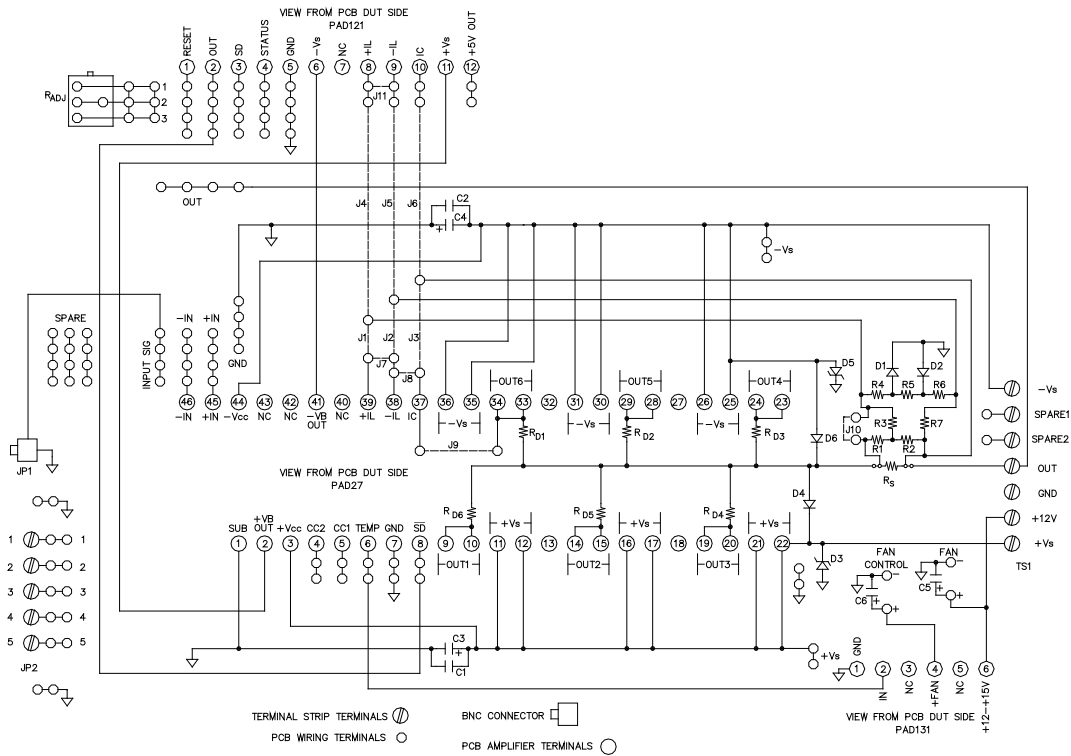

JUMPER SELECTION

To use the PAD127 **without** fold-over current limit insert jumpers J1, 3, 7, 10.

To use the PAD127 **with** fold-over current limit insert jumpers J1, 2, 3.

To use the PAD127 and PAD121 together **without** fold-over current limit insert jumpers J4, 6, 7, 8, 9, 10, 11.

To use the PAD127 and PAD121 together **with** fold-over current limit insert jumpers J4, 5, 6, 7, 8, 9.

TOP VIEW

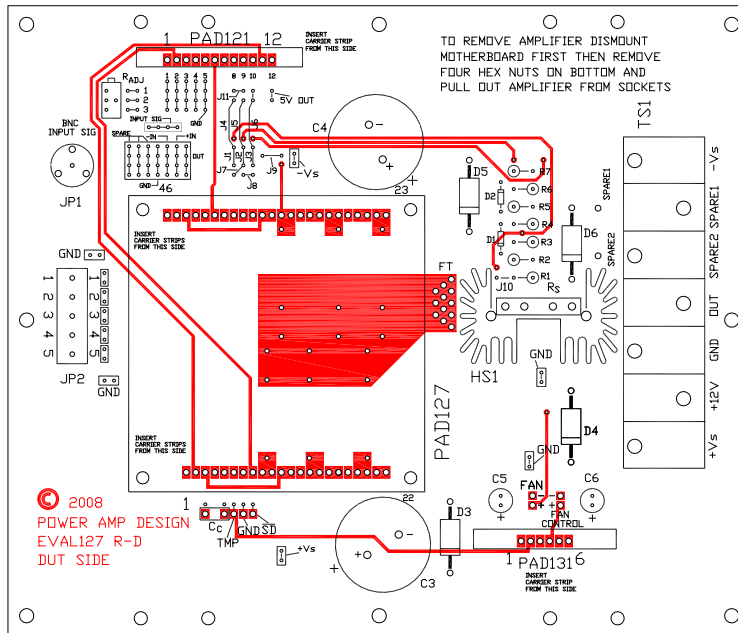

BOTTOM VIEW

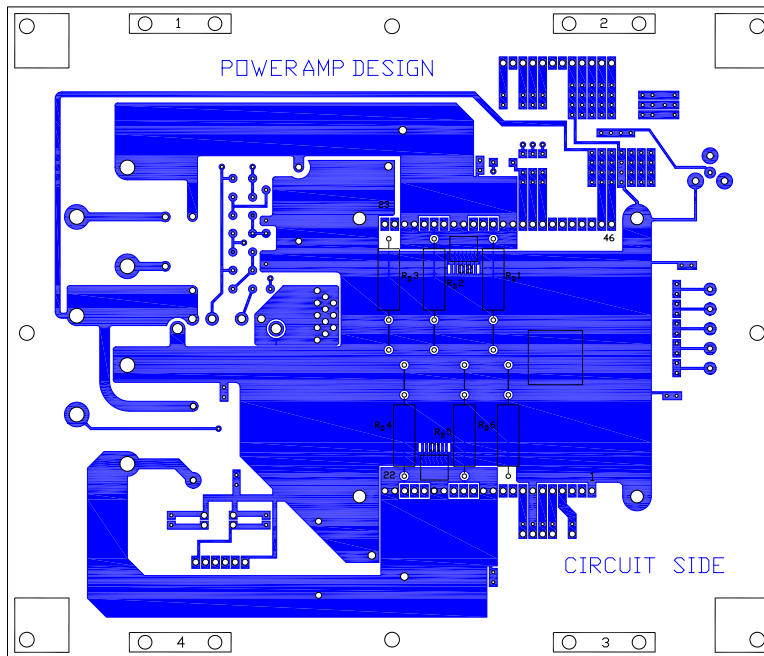

PowerAmp Design ♦ EVAL127 ♦ EVALUATION KIT FOR PADI27

EVAL127 with PAD127 installed. Optional PAD121 and PAD131 also shown installed.



BOARD OUTLINE DIMENSIONS

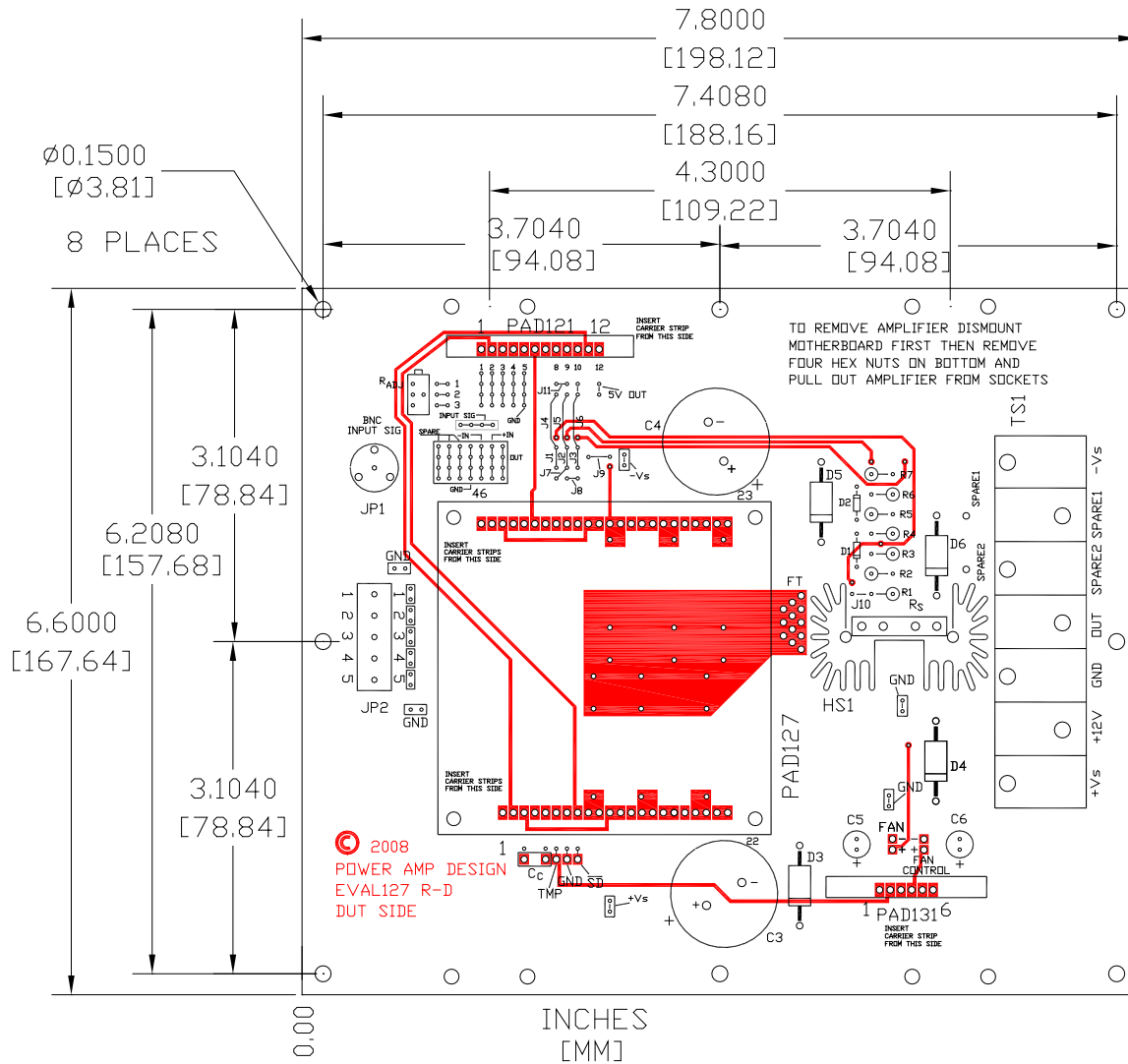

PowerAmp Design ♦ EVAL127 ♦ EVALUATION KIT FOR PADI27